

PUMP STATION No.3

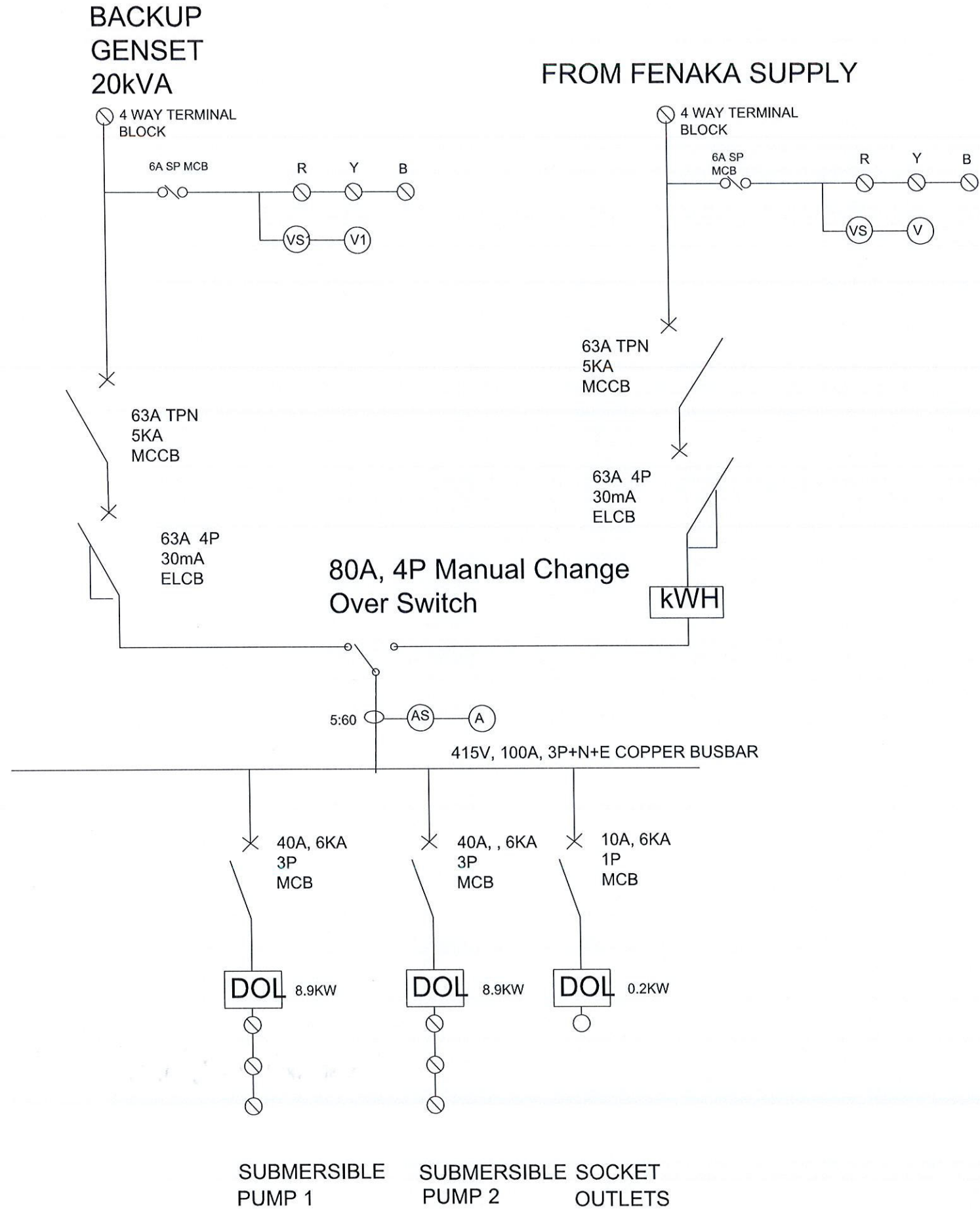

DESIGNED BY : A.WAHID

LICENSE : MEB/2005/419

SIGNATURE : *A. Wahid*

CONSULTANCY SERVICES FOR SURVEY & DESIGN OF SEWERAGE FACILITIES IN HA. BAARAH, MALDIVES

CLIENT: MINISTRY OF ENVIRONMENT AND ENERGY

PROJECT NUMBER: -

DATE: MARCH 2017

ENGINEER: - Abdulla Wahid

CHECKED BY: -

DRAWN BY: - Mohamed Saif



RIYAN PRIVATE LIMITED

Tel: +9603315040 Fax: +9603310776

www.riyan.com.mv

3rd floor, H. Azim, Amisememogal, Malé

Title: POWER LAYOUT SINGLE LINE DIAGRAM FOR PSS

Page: E-03

The contents of these drawings remain as a property of Riyan Private Limited. Any use other than those expressly stated is a violation of this copyright.

HA. BAARAH PS No.3

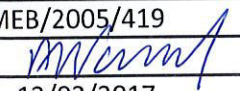
PUMP STATION No.2											
	Description	Oerating Cycle	Other Considerations	Qty (Nos.)	Power Ratings (Watt)	Current Rating (A)	DF	PF	Total Active Power (Watt)	Total Active Power (VA)	Total 3Ph Load (A)
1	Pump	2 (1 Duty ,1 stand by)	Controlled By Level sensors (float switch)	2	8900	12.85	1.00	1	17800	10277.1	25.69
2	1 x Socket Outlet 13A			1	200	0.29	1.00	1	200	115.5	0.29
3	Sub Total										25.98
Riyan Pvt. Ltd.			Client: M.E.E				Calculated by: Abdulla Wahid				
H.Azum			Project: HA. Baarah Sewerage System				Licence : MEB/2005/419				
Ameenee magu			Calculation: Load Calculation of PS3				Signature: 				
Male'			Title: Electric Load Calculation				Date 12/03/2017				

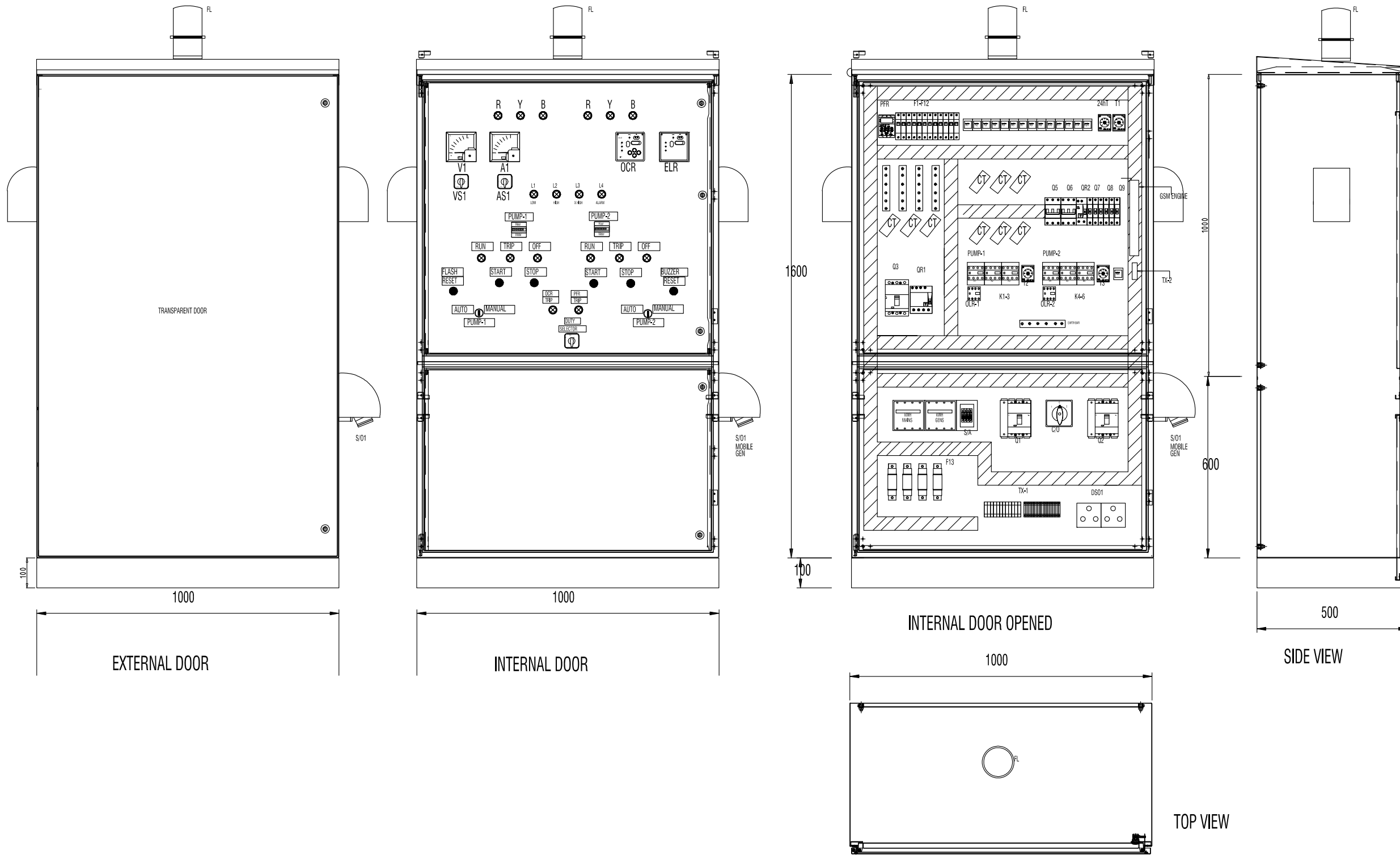

TYPICAL DETAIL FOR PUMP STATION CONTROL PANEL

CONSULTANCY SERVICES FOR SURVEY & DESIGN
 OF SEWERAGE FACILITIES IN HA. BAARAH, MALDIVES
 CLIENT: MINISTRY OF ENVIRONMENT AND ENERGY

PROJECT NUMBER :-
 DATE: MARCH 2017
 ENGINEER :- Abdulla Wahid
 CHECKED BY :-
 DRAWN BY :- Mohamed Saif

Rev no	Date

The contents of these drawings remain as a property of Riyan Private Limited. Any use other than those expressly stated is a violation of this copyright.

Profile 18

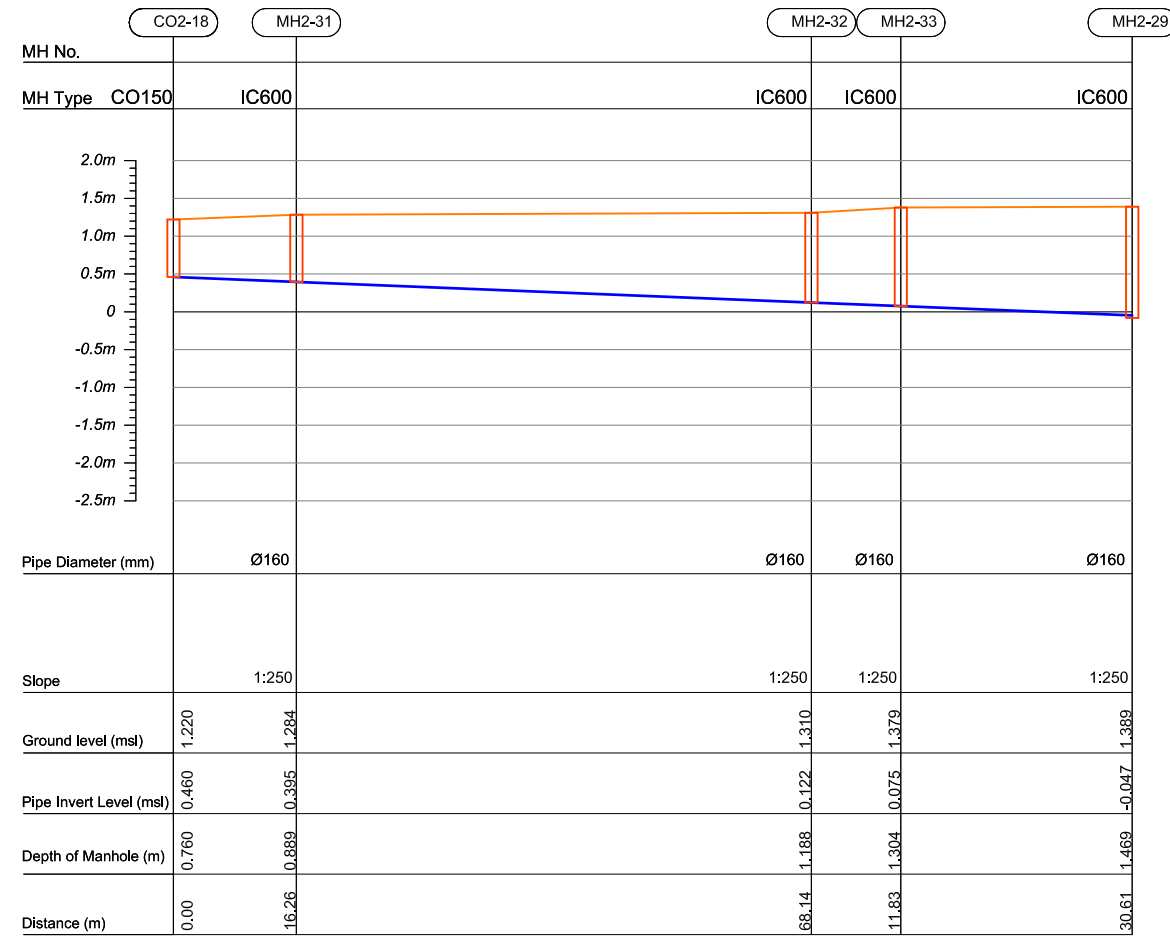

Profile 19

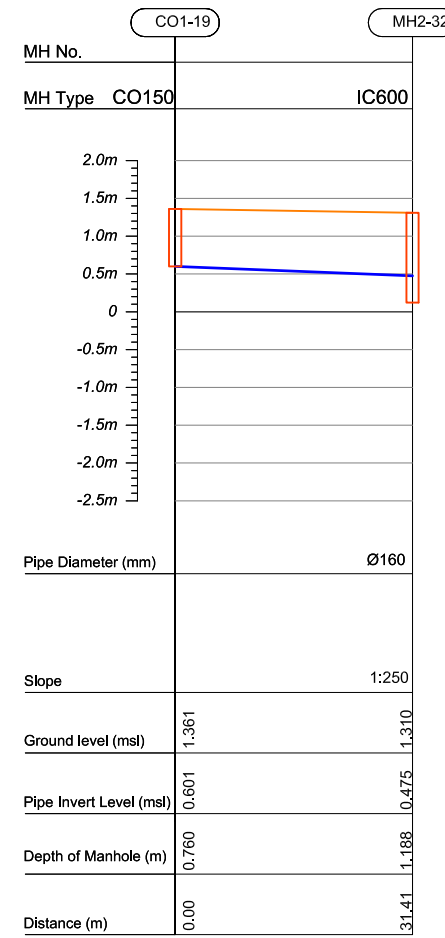

Profile 20

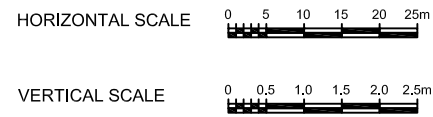
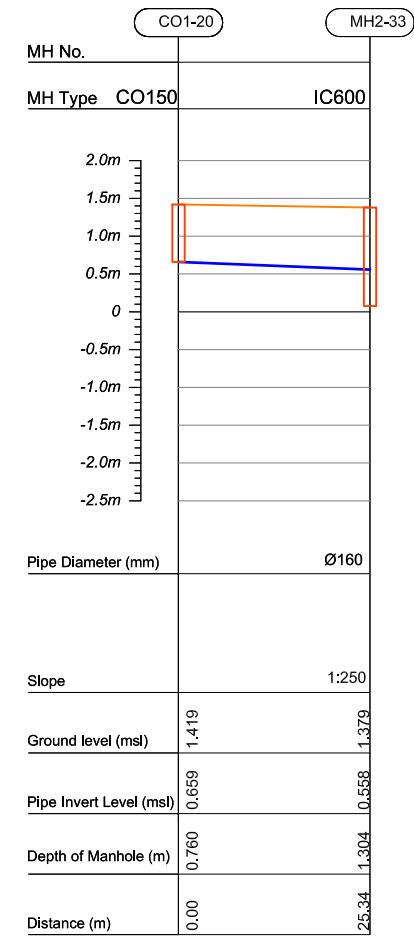

- CO150 — Cleanout Ø150
- IC600 — HDPE Manhole Ø600
- PS — Pump Station

CONSULTANCY SERVICES FOR SURVEY & DESIGN OF SEWERAGE FACILITIES IN HA.BAARAH, MALDIVES
 CLIENT: MINISTRY OF ENVIRONMENT AND ENERGY
 PROJECT NUMBER: -
 DATE: MARCH 2017
 ENGINEER: - Mohamed Saif Saheed
 CHECKED BY: - Ihsan Waheed
 DRAWN BY: - Zainab Abtheen Ali Rasheed

Rev no	Date



RYAN PRIVATE LIMITED

t: +9603315049 f: +9603310776
 e: info@ryan.com.mv
 w: www.ryan.com.mv
 3rd floor, H. Azum, Ameenemogaa, Male'

Title: PS2:Profile 18 to 20

Page: PS2-12/20

The contents of these drawings remain as a property of RYAN Private Limited. Any use other than those expressly stated is a violation of this copyright.

Profile 21

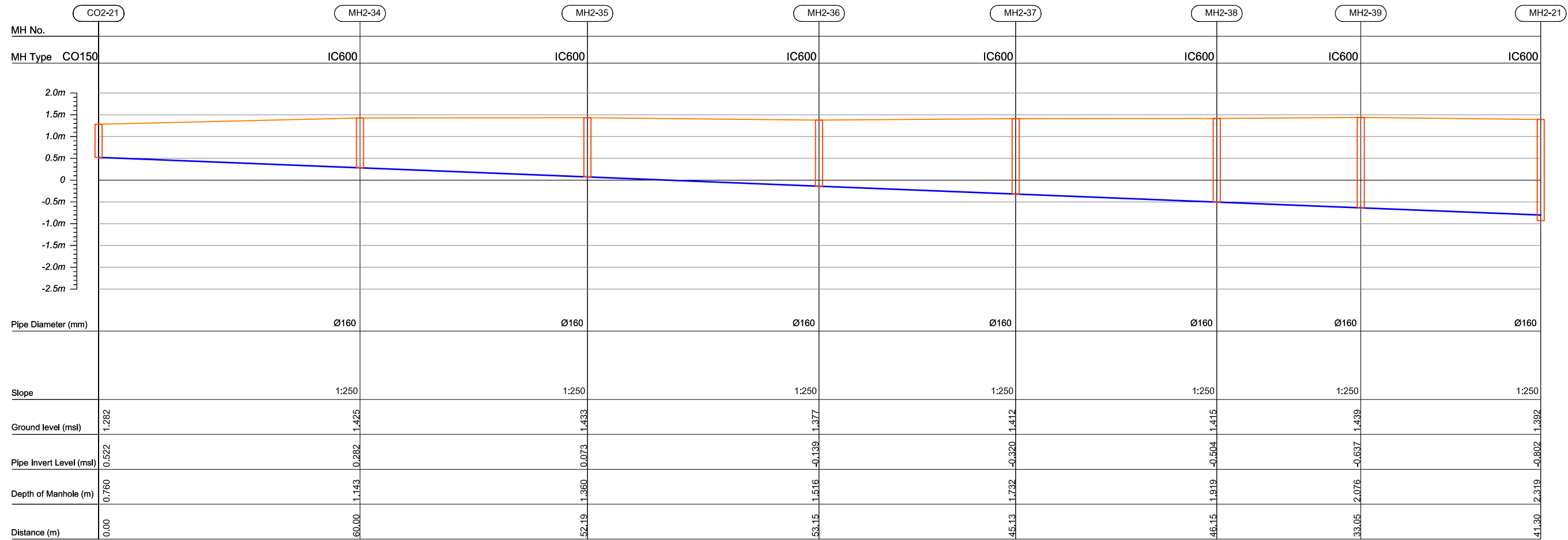

HORIZONTAL SCALE 0 5 10 15 20 25m

VERTICAL SCALE 0 0.5 1.0 1.5 2.0 2.5m

- CO150 — Cleanout Ø150
- IC600 — HDPE Manhole Ø600
- PS — Pump Station

CONSULTANCY SERVICES FOR SURVEY & DESIGN OF
SEWERAGE FACILITIES IN HA.BAARAH, MALDIVES
CLIENT: MINISTRY OF ENVIRONMENT AND ENERGY

PROJECT NUMBER: -
DATE: MARCH 2017
ENGINEER: - Mohamed Saif Saeed
CHECKED BY: - Ihsan Waheed
DRAWN BY: - Zainab Abtheen Ali Rasheed

Rev no Date



RYAN PRIVATE LIMITED

t: +9603315049 f: +9603310776
e: info@ryan.com.mv
w: www.ryan.com.mv
3rd floor, H. Azum, Ameenemogaa, Male'

Title: PS2:Profile 21

Page: PS2-13/20

The contents of these drawings remain as a property of RYAN Private Limited. Any use other than those expressly stated is a violation of this copyright.

Profile 22

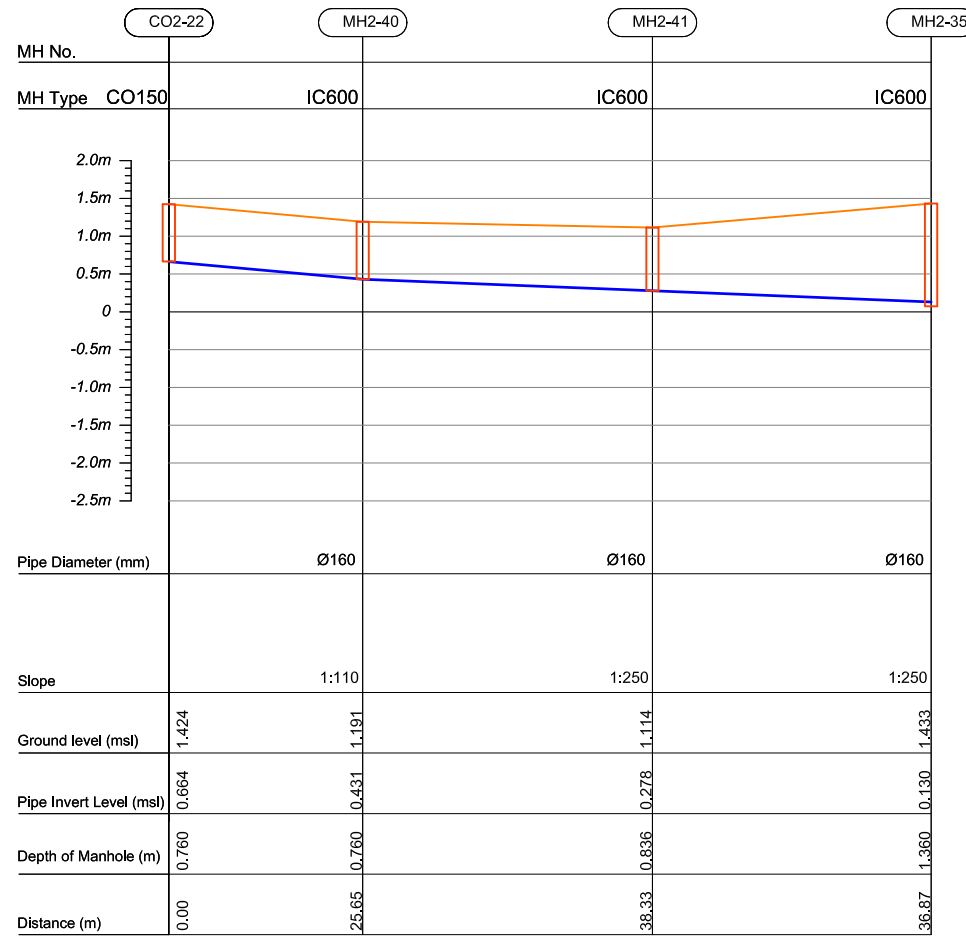

Profile 23

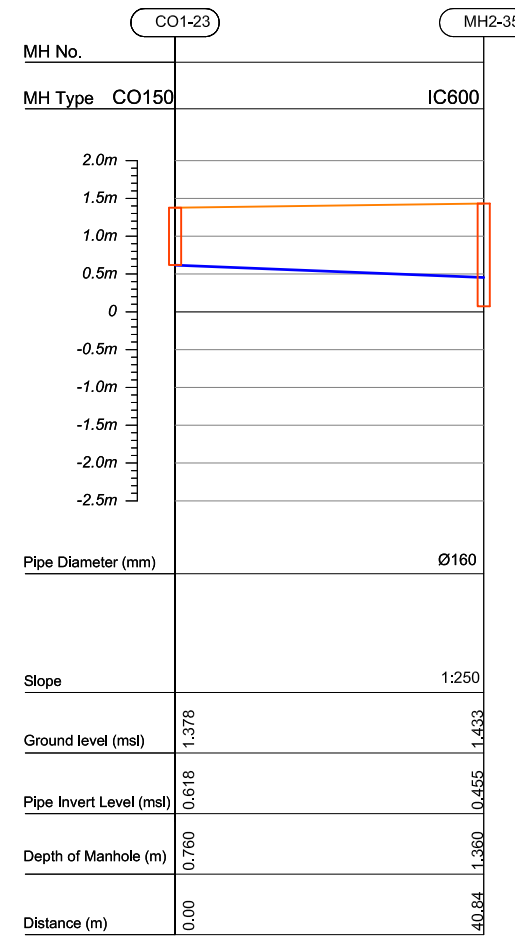

HORIZONTAL SCALE 0 5 10 15 20 25m

VERTICAL SCALE 0 0.5 1.0 1.5 2.0 2.5m

CO150 — Cleanout Ø150
 IC600 — HDPE Manhole Ø600
 PS — Pump Station

CONSULTANCY SERVICES FOR SURVEY & DESIGN OF
 SEWERAGE FACILITIES IN HA.BAARAH, MALDIVES
 CLIENT: MINISTRY OF ENVIRONMENT AND ENERGY
 PROJECT NUMBER: -
 DATE: MARCH 2017
 ENGINEER: - Mohamed Saif Saeed
 CHECKED BY: - Ihsan Waheed
 DRAWN BY: - Zainab Abdooneen Ali Rasheed

Rev no	Date
1	



RYAN PRIVATE LIMITED

t: +9603315049 f: +9603310776
 e: info@ryan.com.mv
 w: www.ryan.com.mv
 3rd floor, H. Azum, Ameenemoguu, Male'

Title: PS2:Profile 22 to 23

Page: PS2-14/20

The contents of these drawings remain as a property of RYAN Private Limited. Any use other than those expressly stated is a violation of this copyright.

Profile 24

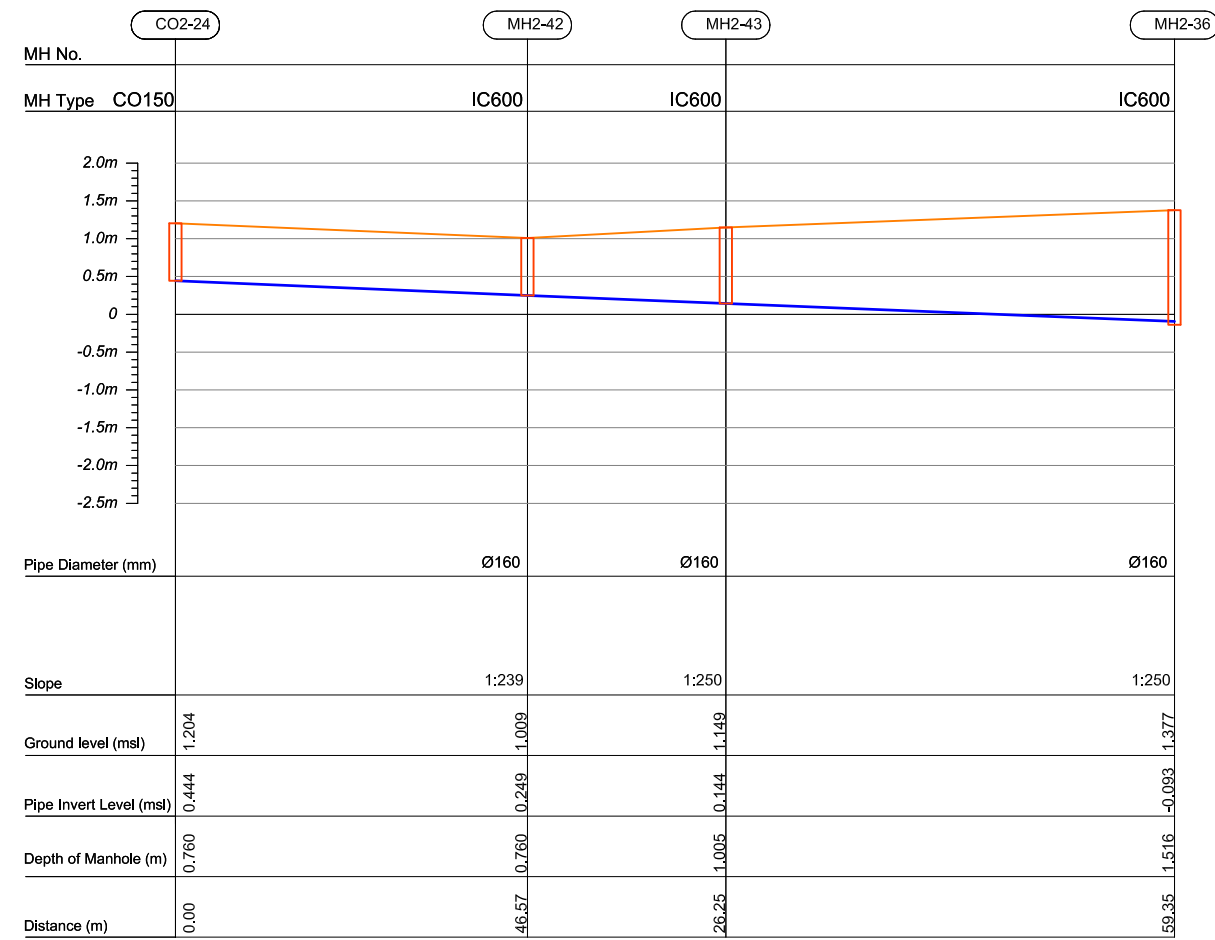

Profile 25

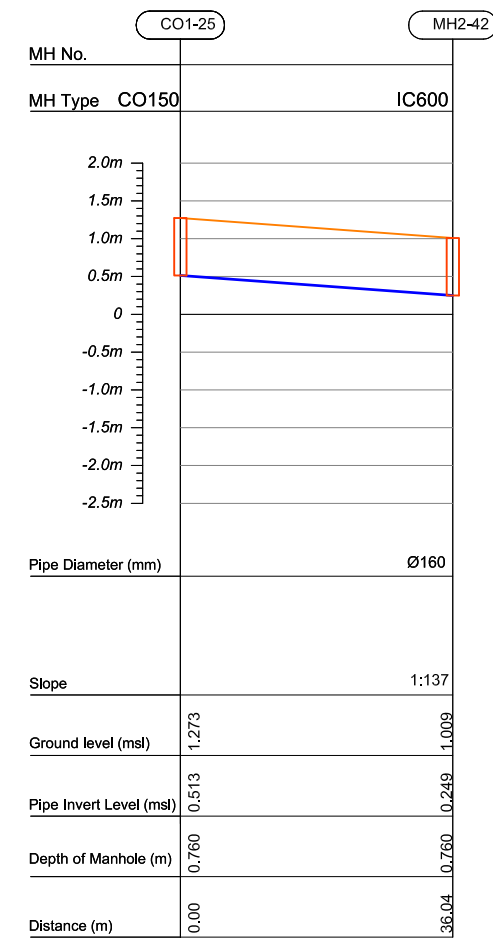

HORIZONTAL SCALE

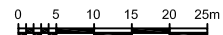

VERTICAL SCALE

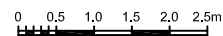

- CO150 — Cleanout Ø150
- IC600 — HDPE Manhole Ø600
- PS — Pump Station

CONSULTANCY SERVICES FOR SURVEY & DESIGN OF SEWERAGE FACILITIES IN HA.BAARAH, MALDIVES
 CLIENT: MINISTRY OF ENVIRONMENT AND ENERGY
 PROJECT NUMBER: -
 DATE: MARCH 2017
 ENGINEER: - Mohamed Saif Saeed
 CHECKED BY: - Ihsan Waheed
 DRAWN BY: - Zainab Abdeen Ali Rasheed

Rev no	Date



RYAN PRIVATE LIMITED

t: +9603315049 f: +9603310776
 e: info@ryan.com.mv
 w: www.ryan.com.mv
 3rd floor, H. Azum, Ameenemogaa, Male'

Title: PS2:Profile 24 to 25

Page: PS2-15/20

The contents of these drawings remain as a property of RYAN Private Limited. Any use other than those expressly stated is a violation of this copyright.

Profile 26

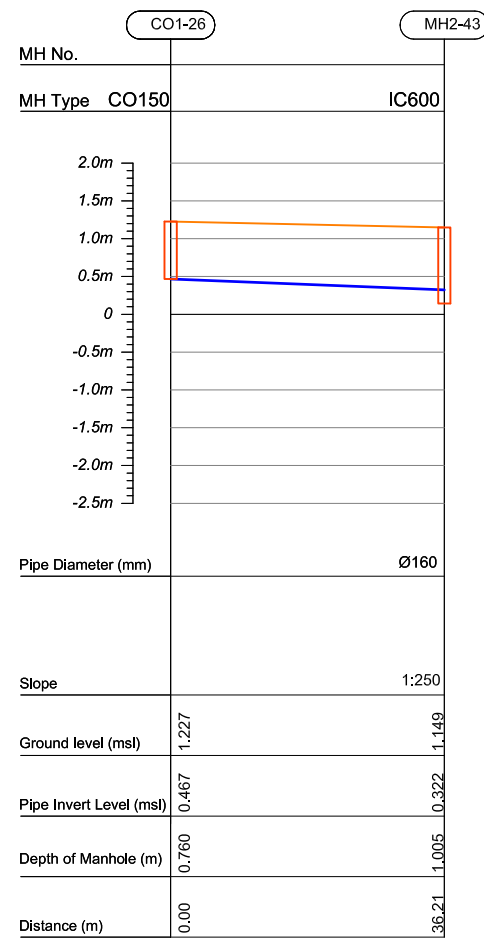

Profile 27

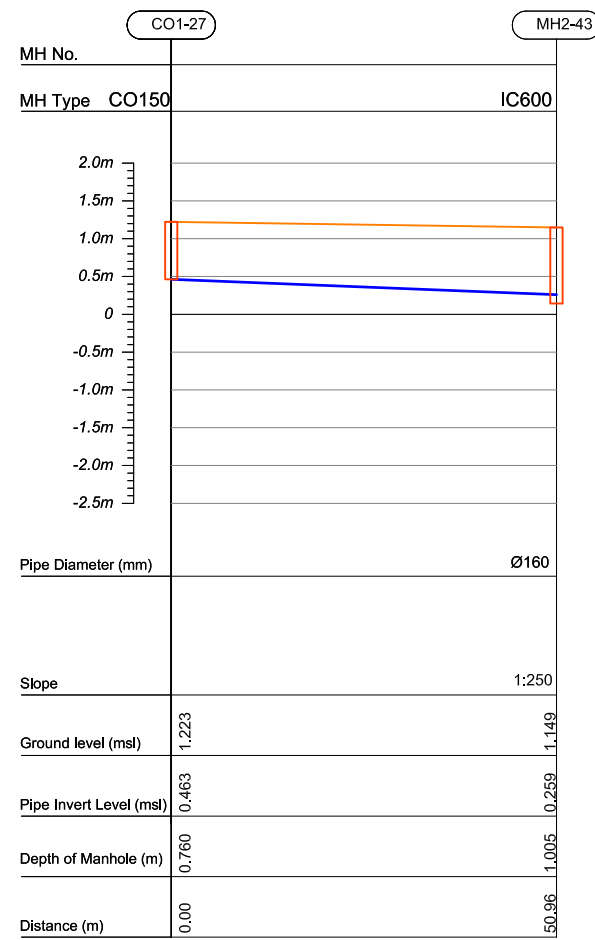

Profile 28

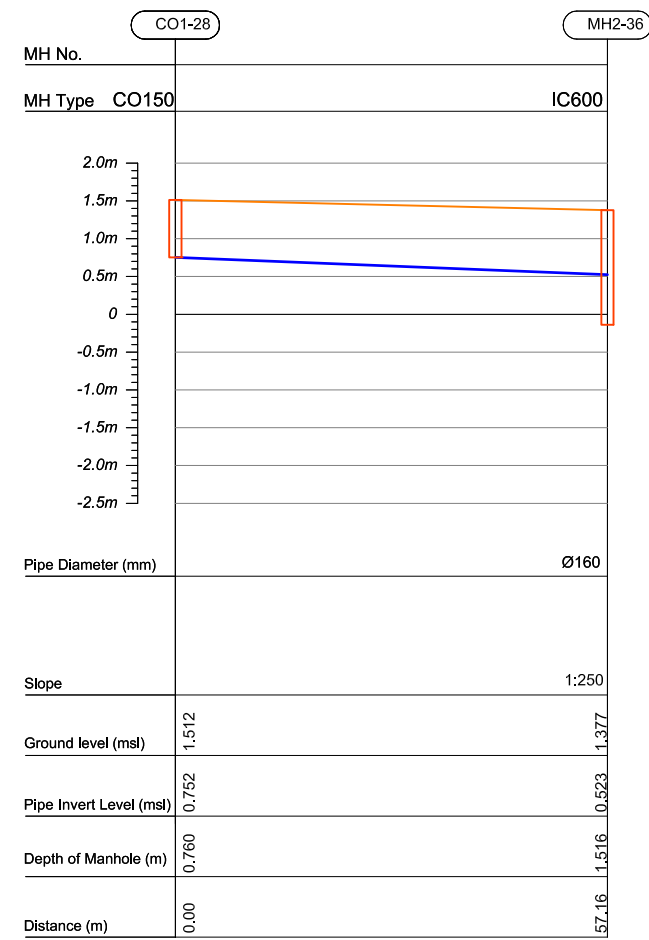

HORIZONTAL SCALE 0 5 10 15 20 25m

VERTICAL SCALE 0 0.5 1.0 1.5 2.0 2.5m

CO150 — Cleanout Ø150
 IC600 — HDPE Manhole Ø600
 PS — Pump Station

CONSULTANCY SERVICES FOR SURVEY & DESIGN OF
 SEWERAGE FACILITIES IN HA.BAARAH, MALDIVES
 CLIENT: MINISTRY OF ENVIRONMENT AND ENERGY
 PROJECT NUMBER: -
 DATE: MARCH 2017
 ENGINEER: - Mohamed Saif Saeed
 CHECKED BY: - Ihsan Waheed
 DRAWN BY: - Zainab Abtheen Ali Rasheed

Rev no	Date



RIYAN PRIVATE LIMITED

t: +9603315049 f: +9603310776
 e: info@riyan.com.mv
 w: www.riyan.com.mv
 3rd floor, H. Azum, Ameenemogaa, Male'

Title: PS2:Profile 26 to 28

Page: PS2-16/20

The contents of these drawings remain as a property of Riyan Private Limited. Any use other than those expressly stated is a violation of this copyright.

Profile 29

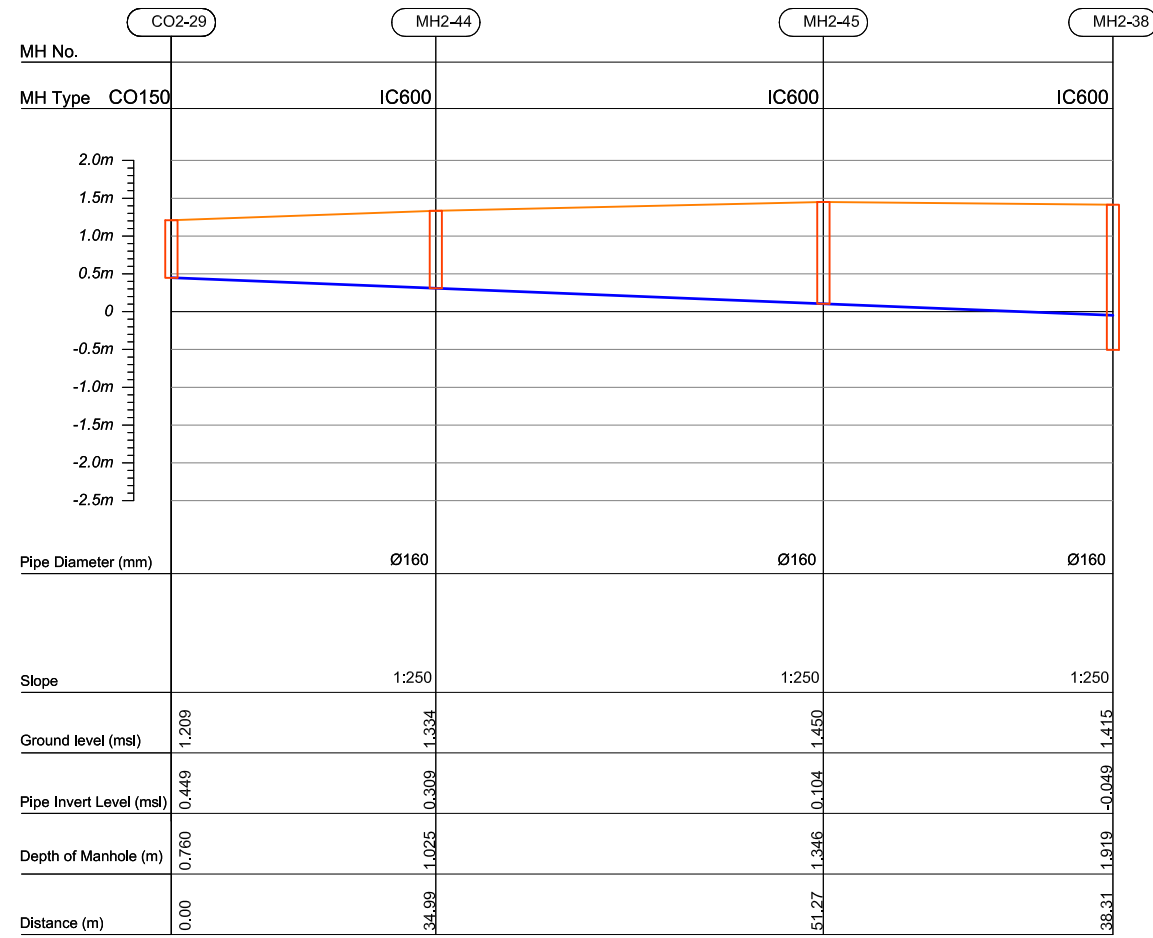

Profile 30

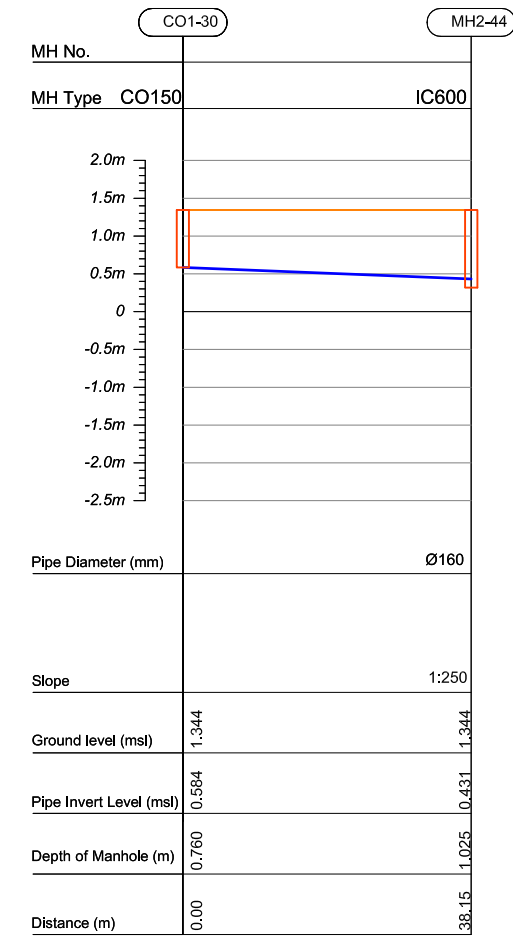

HORIZONTAL SCALE 0 5 10 15 20 25m

VERTICAL SCALE 0 0.5 1.0 1.5 2.0 2.5m

CO150 — Cleanout Ø150
 IC600 — HDPE Manhole Ø600
 PS — Pump Station

CONSULTANCY SERVICES FOR SURVEY & DESIGN OF
 SEWERAGE FACILITIES IN HA.BAARAH, MALDIVES
 CLIENT: MINISTRY OF ENVIRONMENT AND ENERGY
 PROJECT NUMBER: -
 DATE: MARCH 2017
 ENGINEER: - Mohamed Saif Saeed
 CHECKED BY: - Ihsan Waheed
 DRAWN BY: - Zainab Abubteen Ali Rasheed

Rev no	Date
1	



RYAN PRIVATE LIMITED

t: +9603315049 f: +9603310776
 e: info@ryan.com.mv
 w: www.ryan.com.mv
 3rd floor, H. Azum, Ameenemogaa, Male'

Title: PS2:Profile 29 to 30

Page: PS2-17/20

The contents of these drawings remain as a property of RYAN Private Limited. Any use other than those expressly stated is a violation of this copyright.

Profile 31

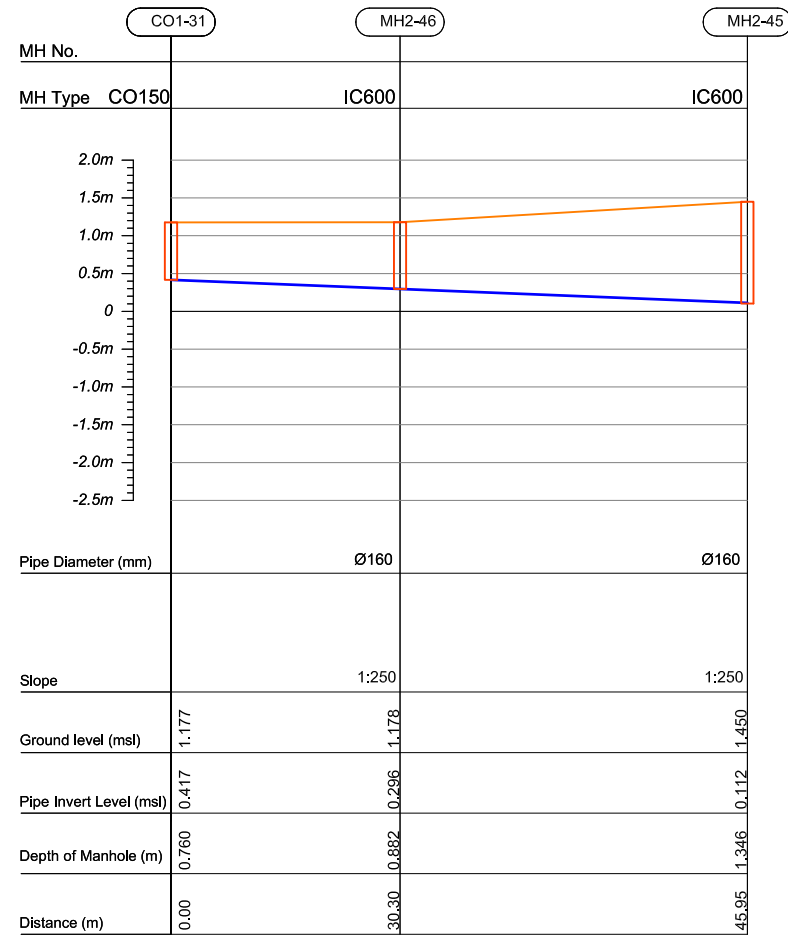

Profile 32

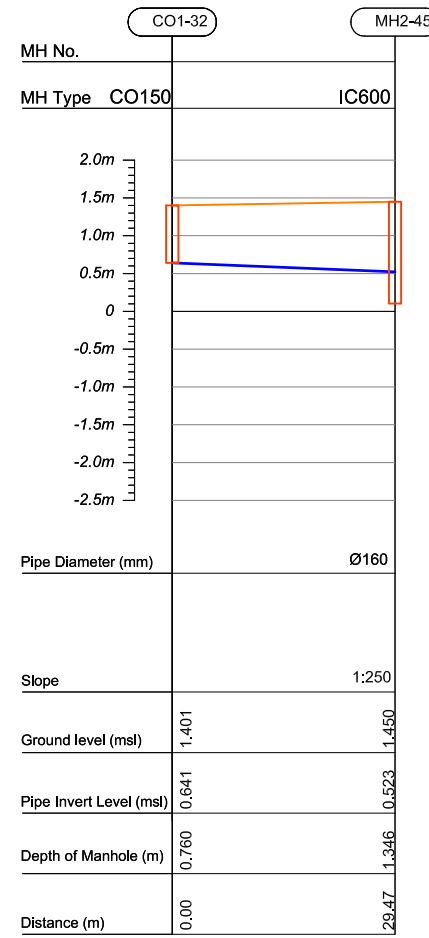

Profile 33

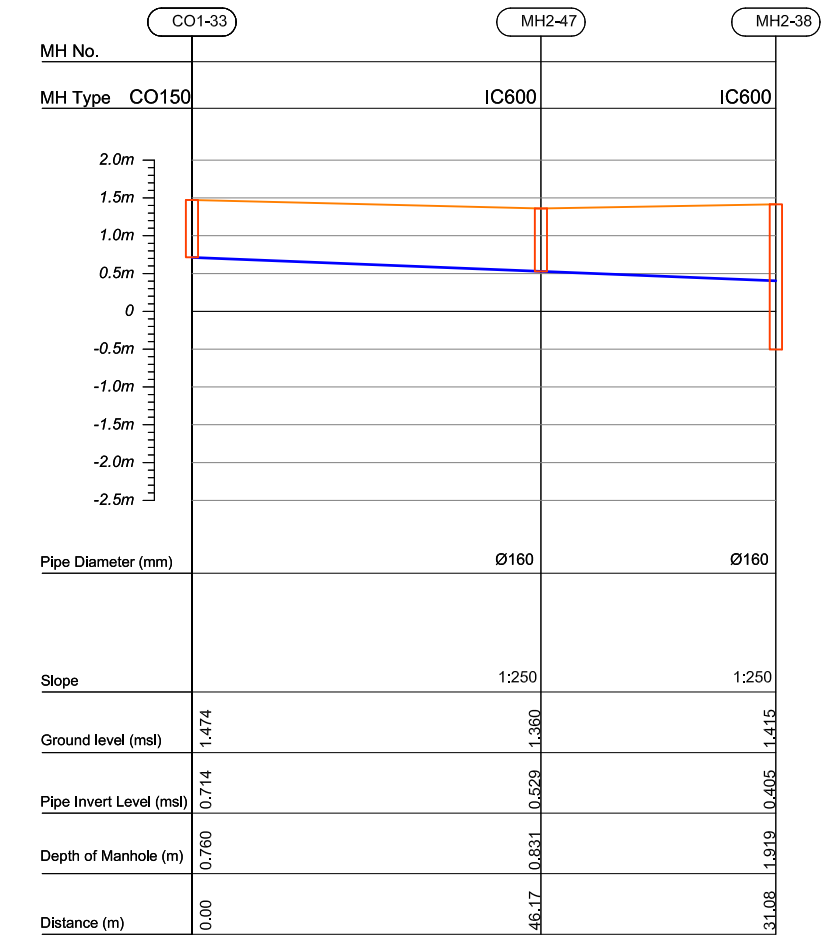

HORIZONTAL SCALE 0 5 10 15 20 25m

VERTICAL SCALE 0 0.5 1.0 1.5 2.0 2.5m

CO150 — Cleanout Ø150
 IC600 — HDPE Manhole Ø600
 PS — Pump Station

CONSULTANCY SERVICES FOR SURVEY & DESIGN OF
 SEWERAGE FACILITIES IN HA.BAARAH, MALDIVES
 CLIENT: MINISTRY OF ENVIRONMENT AND ENERGY
 PROJECT NUMBER: -
 DATE: MARCH 2017
 ENGINEER: - Mohamed Saif Saeed
 CHECKED BY: - Ihsan Waheed
 DRAWN BY: - Zainab Abtheen Ali Rasheed

Rev no	Date
1	



RYAN PRIVATE LIMITED

t: +9603315049 f: +9603310776
 e: info@ryan.com.mv
 w: www.ryan.com.mv
 3rd floor, H. Azum, Ameenemoggu, Male'

Title: PS2:Profile 31 to 33

Page: PS2-18/20

The contents of these drawings remain as a property of RYAN Private Limited. Any use other than those expressly stated is a violation of this copyright.

Profile 34

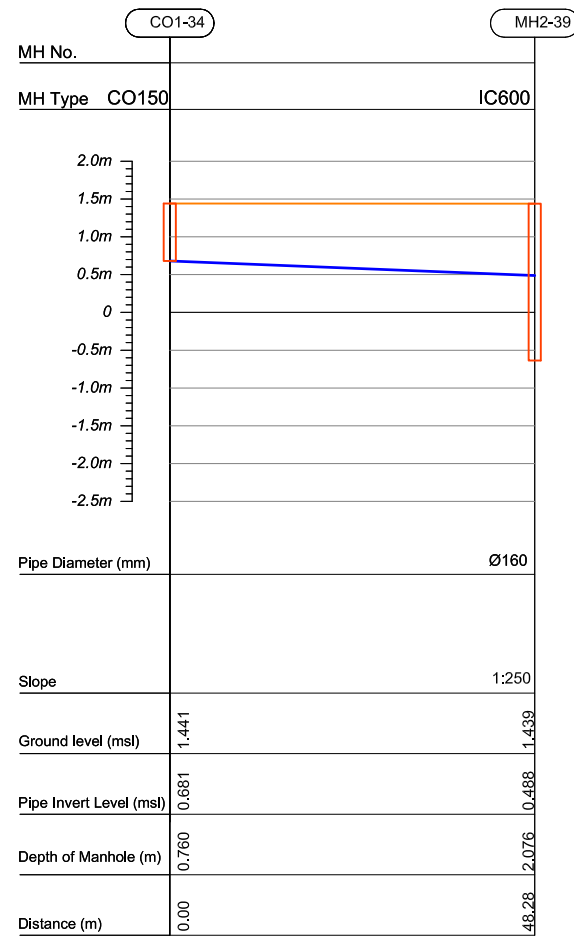

Profile 35

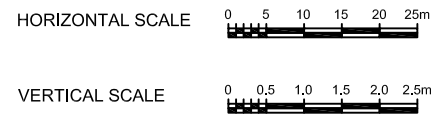
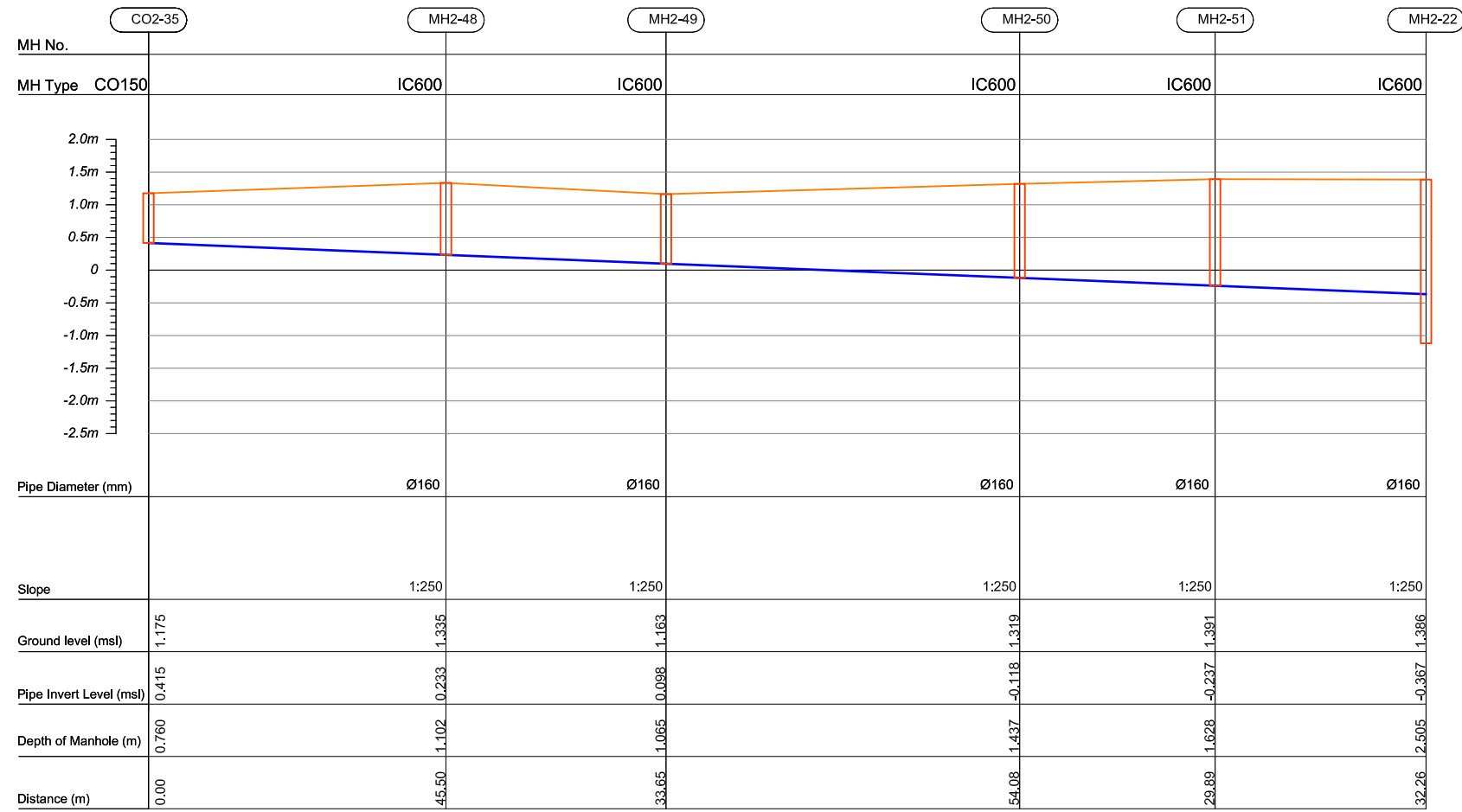

- CO150 — Cleanout Ø150
- IC600 — HDPE Manhole Ø600
- PS — Pump Station

CONSULTANCY SERVICES FOR SURVEY & DESIGN OF
SEWERAGE FACILITIES IN HA.BAARAH, MALDIVES
CLIENT: MINISTRY OF ENVIRONMENT AND ENERGY

PROJECT NUMBER: -
DATE: MARCH 2017
ENGINEER: - Mohamed Saif Saeed
CHECKED BY: - Ihsan Waheed
DRAWN BY: - Zainab Abubteen Ali Rasheed

Rev no Date



RIYAN PRIVATE LIMITED

t: +9603315049 f: +9603310776
e: info@riyan.com.mv
w: www.riyan.com.mv
3rd floor, H. Azum, Ameenemogaa, Male'

Title: PS2:Profile 34 to 35

Page: PS2-19/20

The contents of these drawings remain as a property of Riyan Private Limited. Any use other than those expressly stated is a violation of this copyright

Profile 36

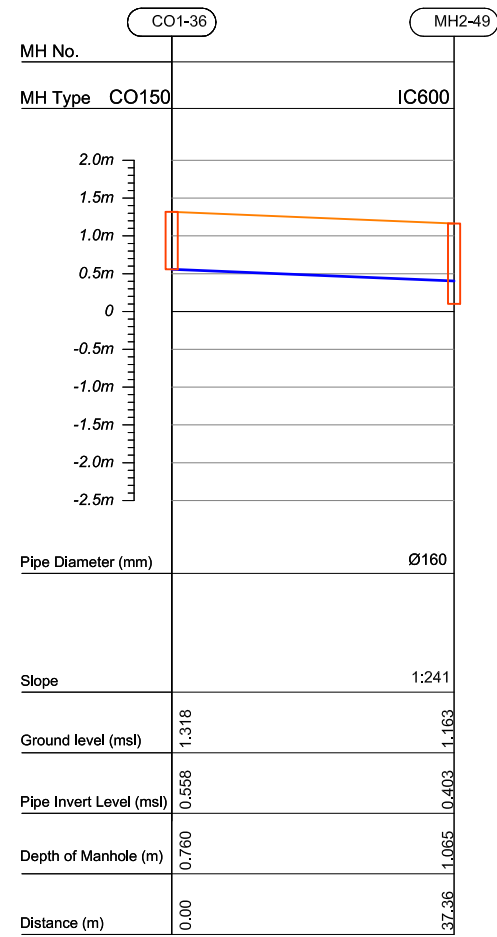

Profile 37

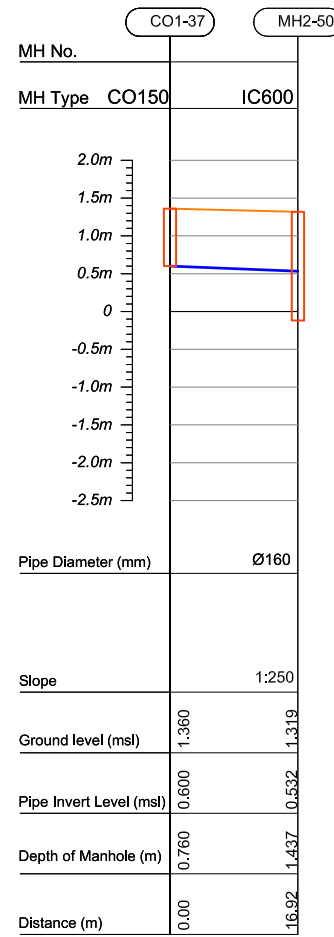

Profile 38

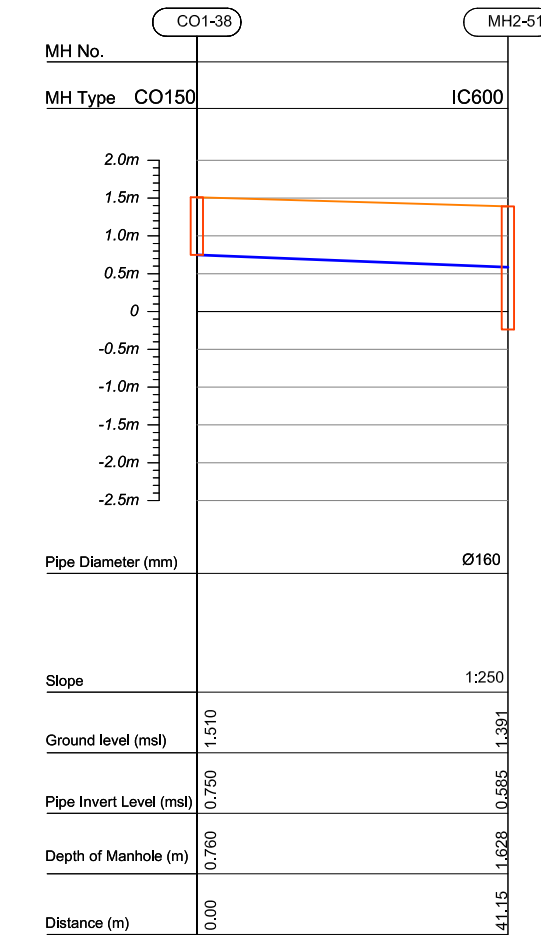

HORIZONTAL SCALE

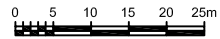

VERTICAL SCALE

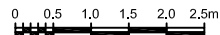

CO150 — Cleanout Ø150
 IC600 — HDPE Manhole Ø600
 PS — Pump Station

CONSULTANCY SERVICES FOR SURVEY & DESIGN OF
 SEWERAGE FACILITIES IN HA.BAARAH, MALDIVES
 CLIENT: MINISTRY OF ENVIRONMENT AND ENERGY
 PROJECT NUMBER: -
 DATE: MARCH 2017
 ENGINEER: - Mohamed Saif Saeed
 CHECKED BY: - Ihsan Waheed
 DRAWN BY: - Zainab Abtheen Ali Rasheed

Rev no	Date
1	



RIYAN PRIVATE LIMITED

t: +9603315049 f: +9603310776
 e: info@riyan.com.mv
 w: www.riyan.com.mv
 3rd floor, H. Azum, Ameenemoggu, Male'

Title: PS2:Profile 36 to 38

Page: PS2-20/20

The contents of these drawings remain as a property of Riyan Private Limited. Any use other than those expressly stated is a violation of this copyright.

Profile 01

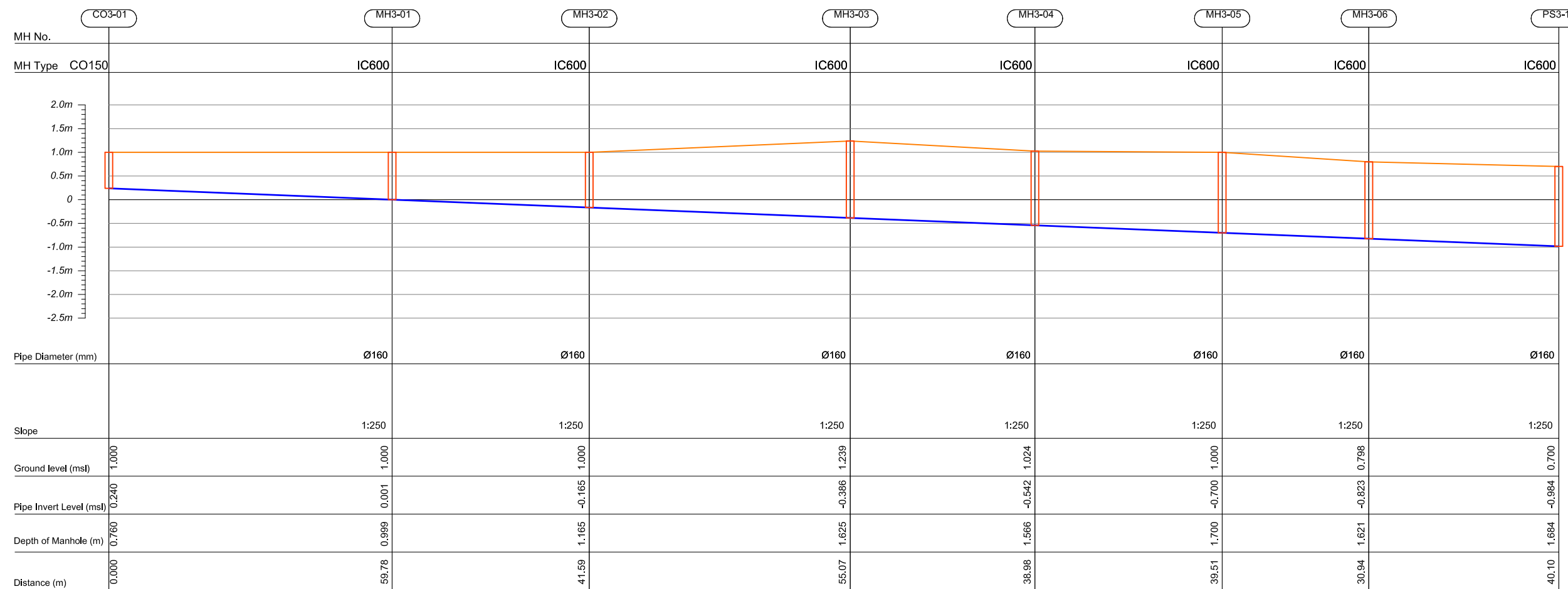

HORIZONTAL SCALE 0 5 10 15 20 25m

VERTICAL SCALE 0 0.5 1.0 1.5 2.0 2.5m

- CO150 — Cleanout Ø150
- IC600 — HDPE Manhole Ø600
- PS — Pump Station

CONSULTANCY SERVICES FOR SURVEY & DESIGN OF SEWERAGE FACILITIES IN HA.BAARAH, MALDIVES
 CLIENT: MINISTRY OF ENVIRONMENT AND ENERGY
 PROJECT NUMBER: -
 DATE: MARCH 2017
 ENGINEER: - Mohamed Saif Saeed
 CHECKED BY: - Ihsan Waheed
 DRAWN BY: - Zainal Abidineen Ali Rasheed

Rev no	Date



RIYAN PRIVATE LIMITED
 t: +9603315049 f: +9603310776
 e: info@riyan.com.mv
 w: www.riyan.com.mv
 3rd floor, H. Azum, Ameenemogaa, Male'

The contents of these drawings remain as a property of Riyan Private Limited. Any use other than those expressly stated is a violation of this copyright.

Profile 02

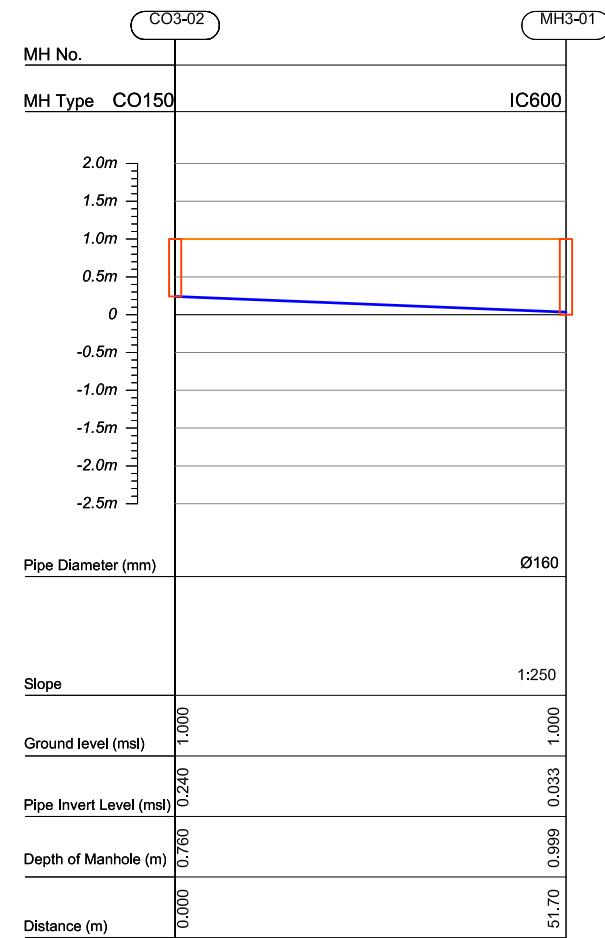

Profile 03

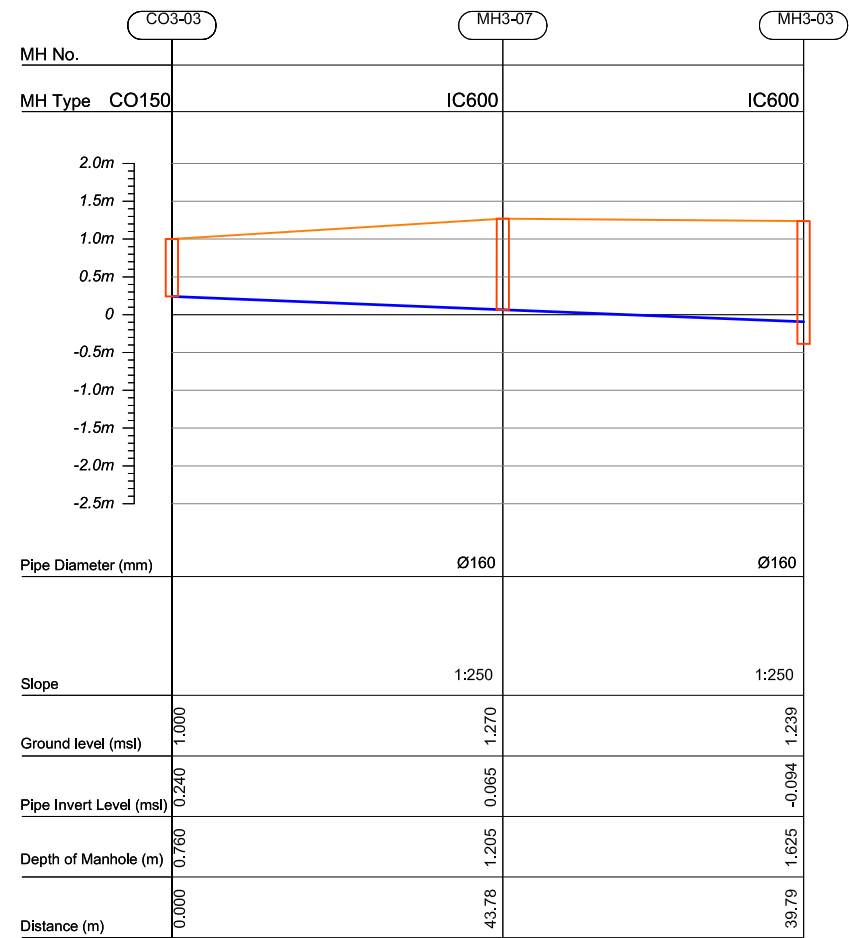

- CO150 — Cleanout Ø150
- IC600 — HDPE Manhole Ø600
- PS — Pump Station

CONSULTANCY SERVICES FOR SURVEY & DESIGN OF SEWERAGE FACILITIES IN HA.BAARAH, MALDIVES
 CLIENT: MINISTRY OF ENVIRONMENT AND ENERGY
 PROJECT NUMBER: -
 DATE: MARCH 2017
 ENGINEER: - Mohamed Saif Saeed
 CHECKED BY: - Ihsan Waheed
 DRAWN BY: - Zainal Abidine Ali Rasheed

Rev no	Date

RIYAN PRIVATE LIMITED
 t: +9603315049 f: +9603310776
 e: info@riyan.com.mv
 w: www.riyan.com.mv
 3rd floor, H. Azum, Ameenemoggu, Male'

The contents of these drawings remain as a property of Riyan Private Limited. Any use other than those expressly stated is a violation of this copyright.

Profile 04

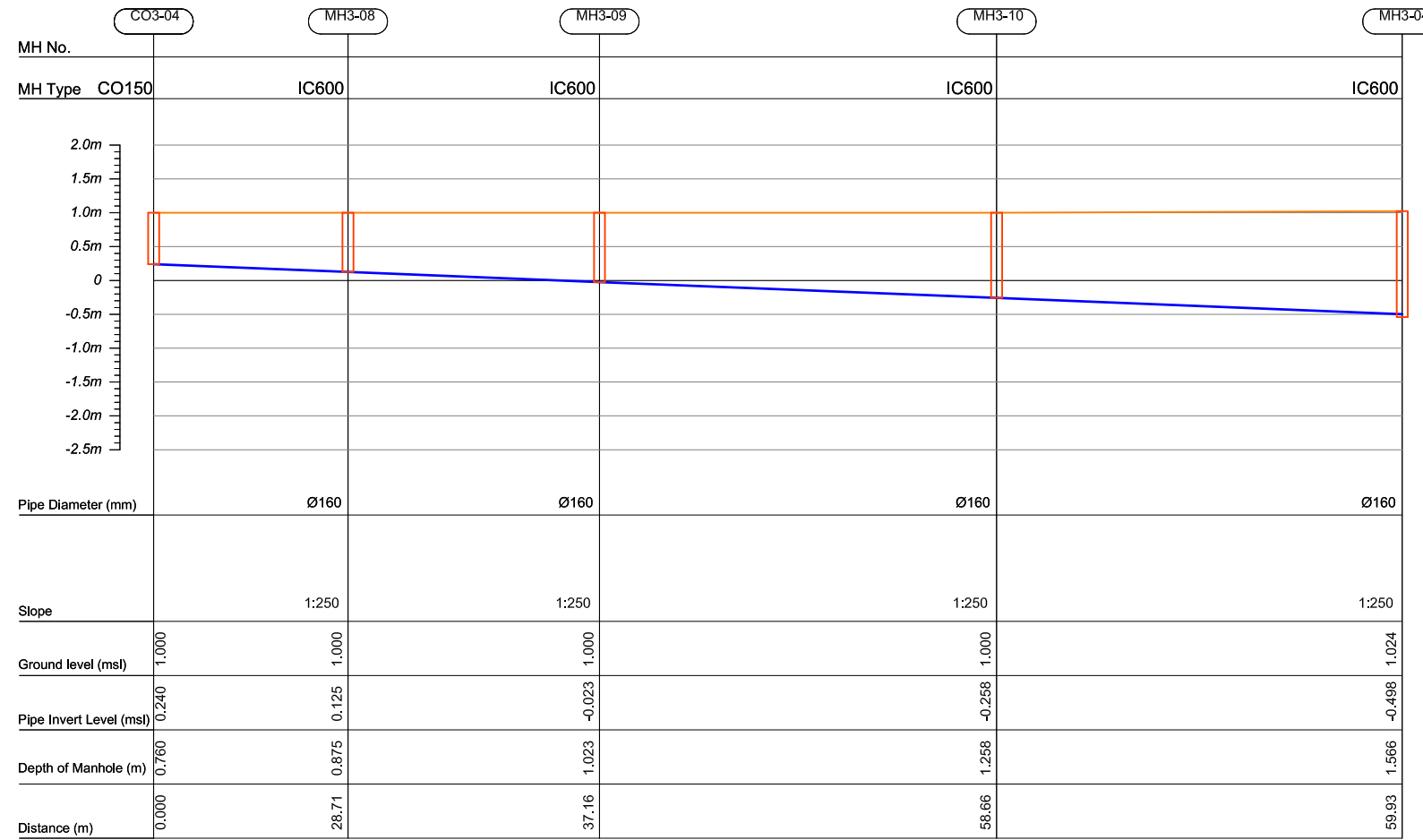

Profile 05

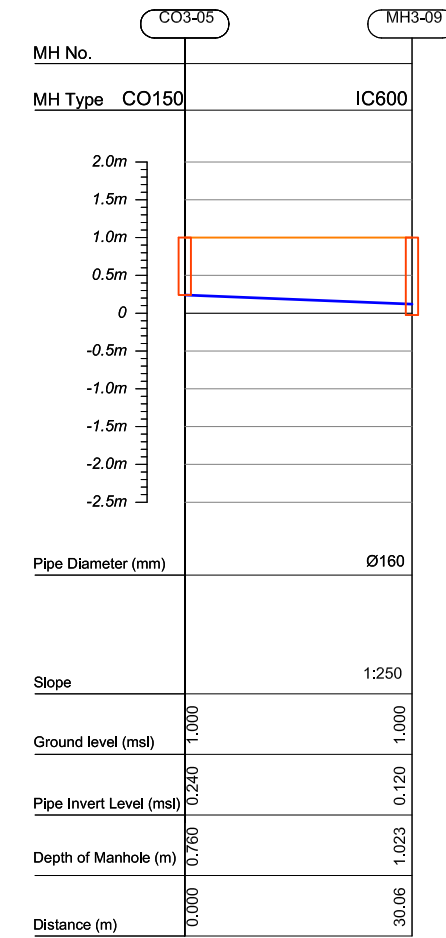

HORIZONTAL SCALE 0 5 10 15 20 25m

VERTICAL SCALE 0 0.5 1.0 1.5 2.0 2.5m

CO150 — Cleanout Ø150
 IC600 — HDPE Manhole Ø600
 PS — Pump Station

CONSULTANCY SERVICES FOR SURVEY & DESIGN OF
 SEWERAGE FACILITIES IN HA.BAARAH, MALDIVES
 CLIENT: MINISTRY OF ENVIRONMENT AND ENERGY
 PROJECT NUMBER: -
 DATE: MARCH 2017
 ENGINEER: - Mohamed Saif Saeed
 CHECKED BY: - Ihsan Waheed
 DRAWN BY: - Zainal Abideen Ali Rasheed

Rev no	Date



RYAN PRIVATE LIMITED

t: +9603315049 f: +9603310776
 e: info@ryan.com.mv
 w: www.ryan.com.mv
 3rd floor, H. Azum, Ameenemogaa, Male'

Title: PS3:Profile 4 to 5

Page: PS3-03/22

The contents of these drawings remain as a property of RYAN Private Limited. Any use other than those expressly stated is a violation of this copyright.

Profile 06

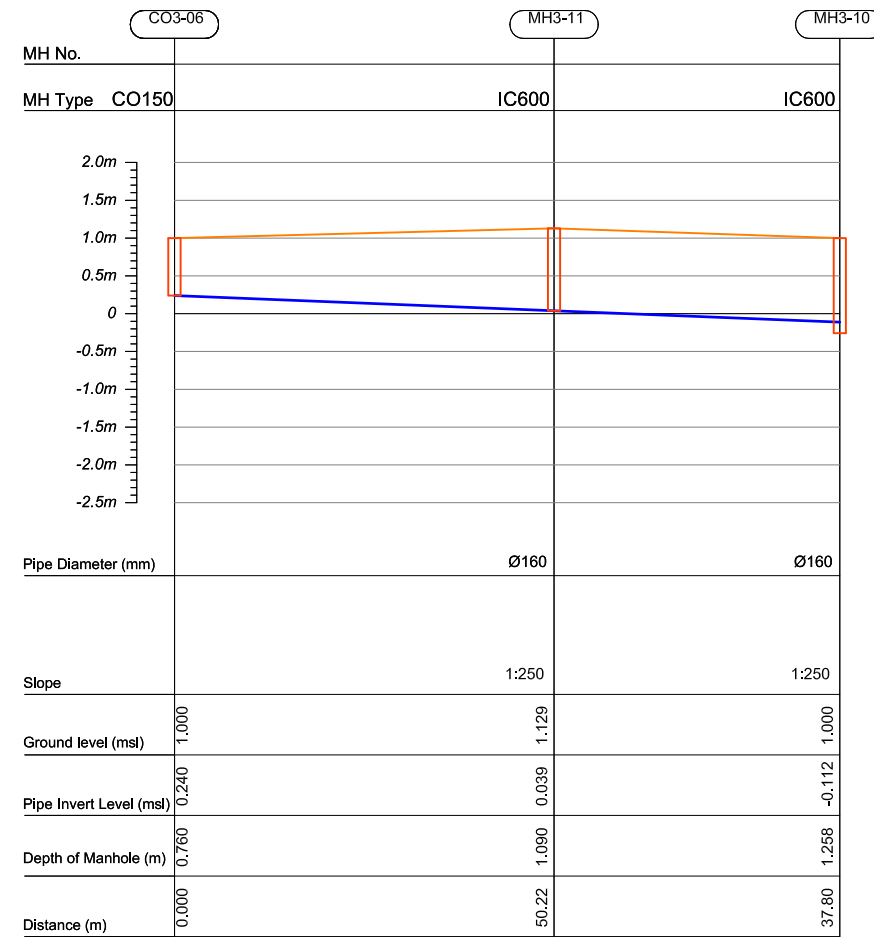

Profile 6A

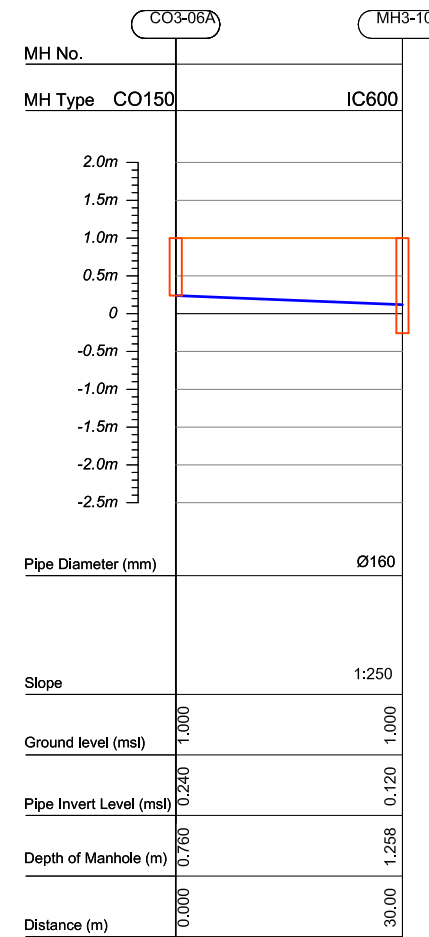

HORIZONTAL SCALE

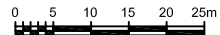

VERTICAL SCALE

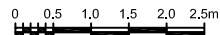

CO150 — Cleanout Ø150
 IC600 — HDPE Manhole Ø600
 PS — Pump Station

CONSULTANCY SERVICES FOR SURVEY & DESIGN OF
 SEWERAGE FACILITIES IN HA.BAARAH, MALDIVES
 CLIENT: MINISTRY OF ENVIRONMENT AND ENERGY
 PROJECT NUMBER: -
 DATE: MARCH 2017
 ENGINEER: - Mohamed Saif Saeed
 CHECKED BY: - Ihsan Waheed
 DRAWN BY: - Zainab Abdooneen Ali Rasheed

Rev no	Date
1	



RYAN PRIVATE LIMITED

t: +9603315049 f: +9603310776
 e: info@ryan.com.mv
 w: www.ryan.com.mv
 3rd floor, H. Azum, Ameenemogaa, Male'

Title: PS3:Profile 6 to 6A

Page: PS3-04/22

The contents of these drawings remain as a property of RYAN Private Limited. Any use other than those expressly stated is a violation of this copyright.

Profile 07

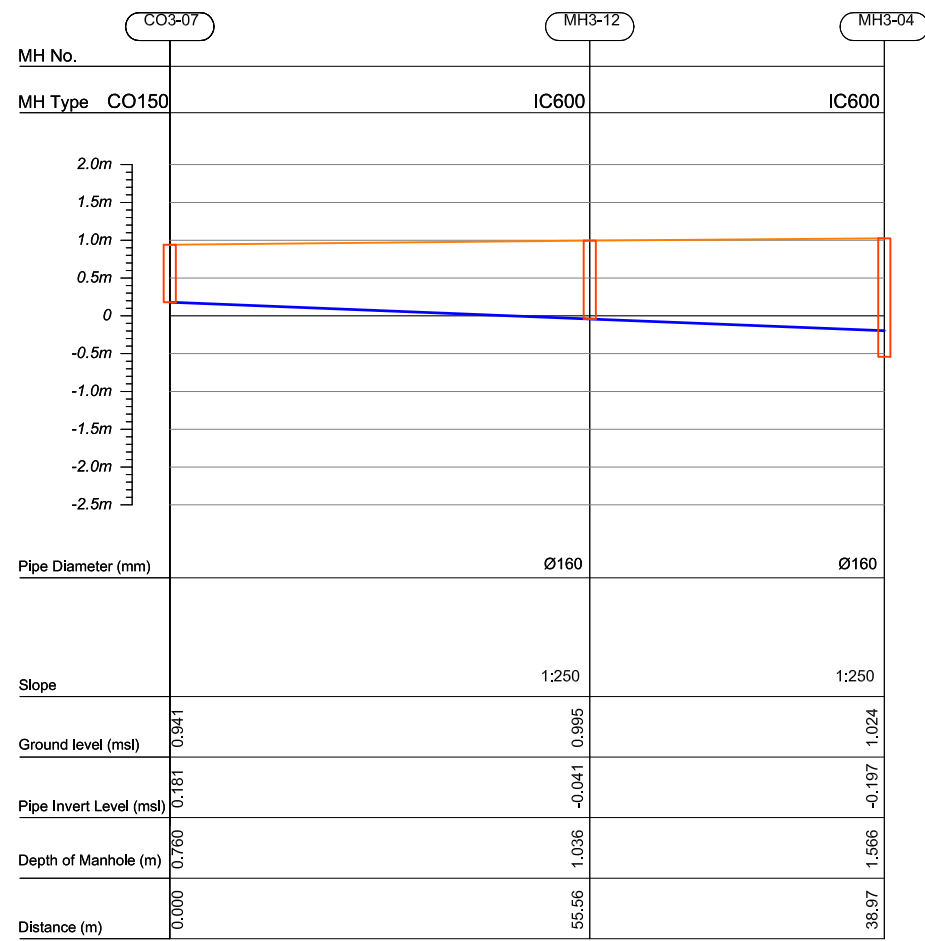

Profile 08

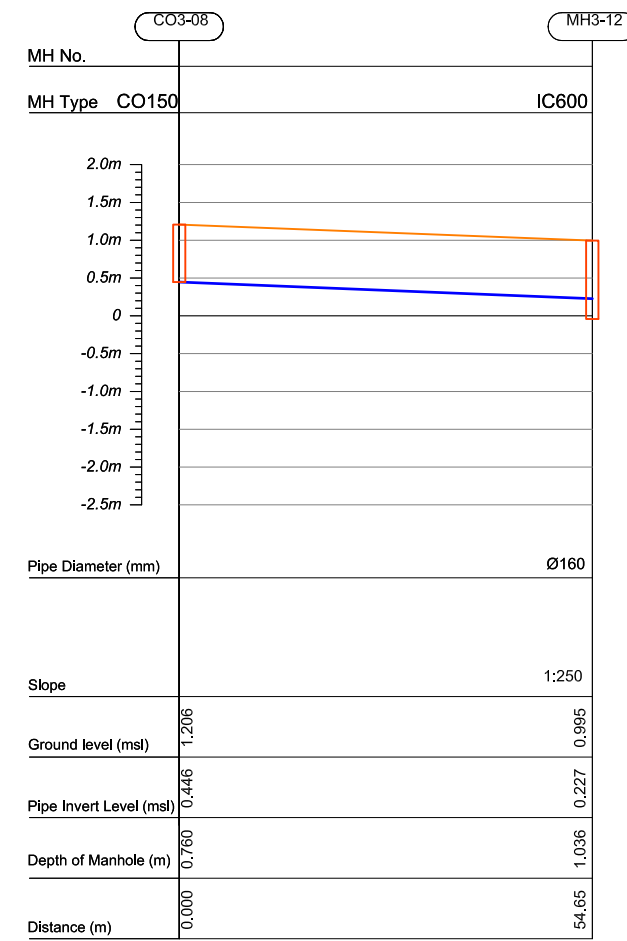

HORIZONTAL SCALE

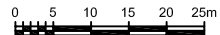

VERTICAL SCALE

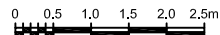

- CO150 — Cleanout Ø150
- IC600 — HDPE Manhole Ø600
- PS — Pump Station

**CONSULTANCY SERVICES FOR SURVEY & DESIGN OF
SEWERAGE FACILITIES IN HA.BAARAH, MALDIVES**
 CLIENT: MINISTRY OF ENVIRONMENT AND ENERGY
 PROJECT NUMBER: -
 DATE: MARCH 2017
 ENGINEER: - Mohamed Saif Saeed
 CHECKED BY: - Ihsan Waheed
 DRAWN BY: - Zainab Abdooneen Ali Rasheed

Rev no	Date



RYAN PRIVATE LIMITED

t: +9603315049 f: +9603310776
 e: info@ryan.com.mv
 w: www.ryan.com.mv
 3rd floor, H. Azum, Ameenemoguu, Male'

Title: PS3:Profile 7 to 8

Page: PS3-05/22

Profile 09

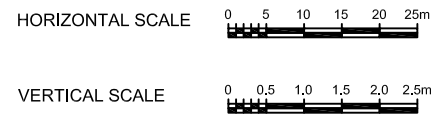
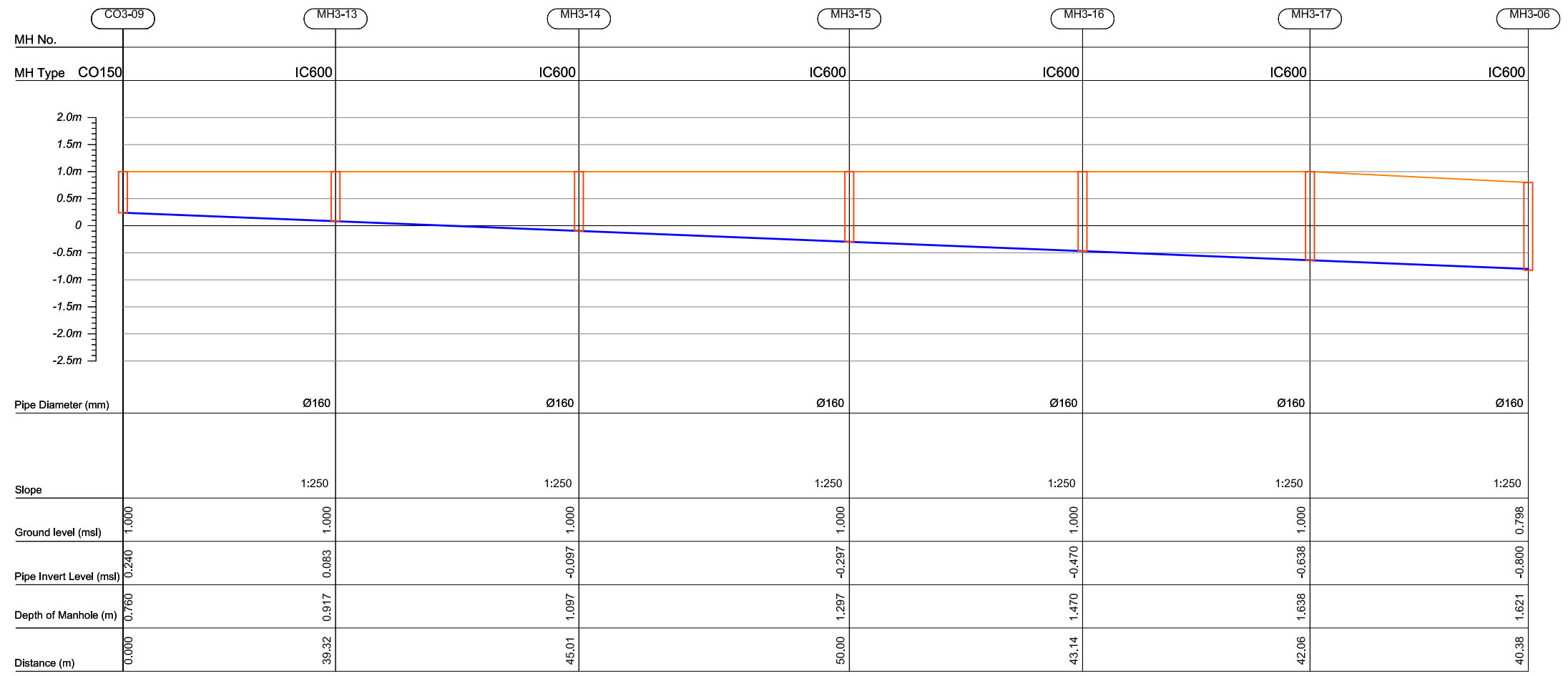

- CO150 — Cleanout Ø150
- IC600 — HDPE Manhole Ø600
- PS — Pump Station

CONSULTANCY SERVICES FOR SURVEY & DESIGN OF SEWERAGE FACILITIES IN HA.BAARAH, MALDIVES
 CLIENT: MINISTRY OF ENVIRONMENT AND ENERGY
 PROJECT NUMBER: -
 DATE: MARCH 2017
 ENGINEER: - Mohamed Saif Saeed
 CHECKED BY: - Ihsan Waheed
 DRAWN BY: - Zainal Abidineen Ali Rasheed

Rev no	Date



RIYAN PRIVATE LIMITED

t: +9603315049 f: +9603310776
 e: info@riyan.com.mv
 w: www.riyan.com.mv
 3rd floor, H. Azum, Ameenemogaa, Male'

The contents of these drawings remain as a property of Riyan Private Limited. Any use other than those expressly stated is a violation of this copyright.

Overall Process and Instrumentation Control Diagram

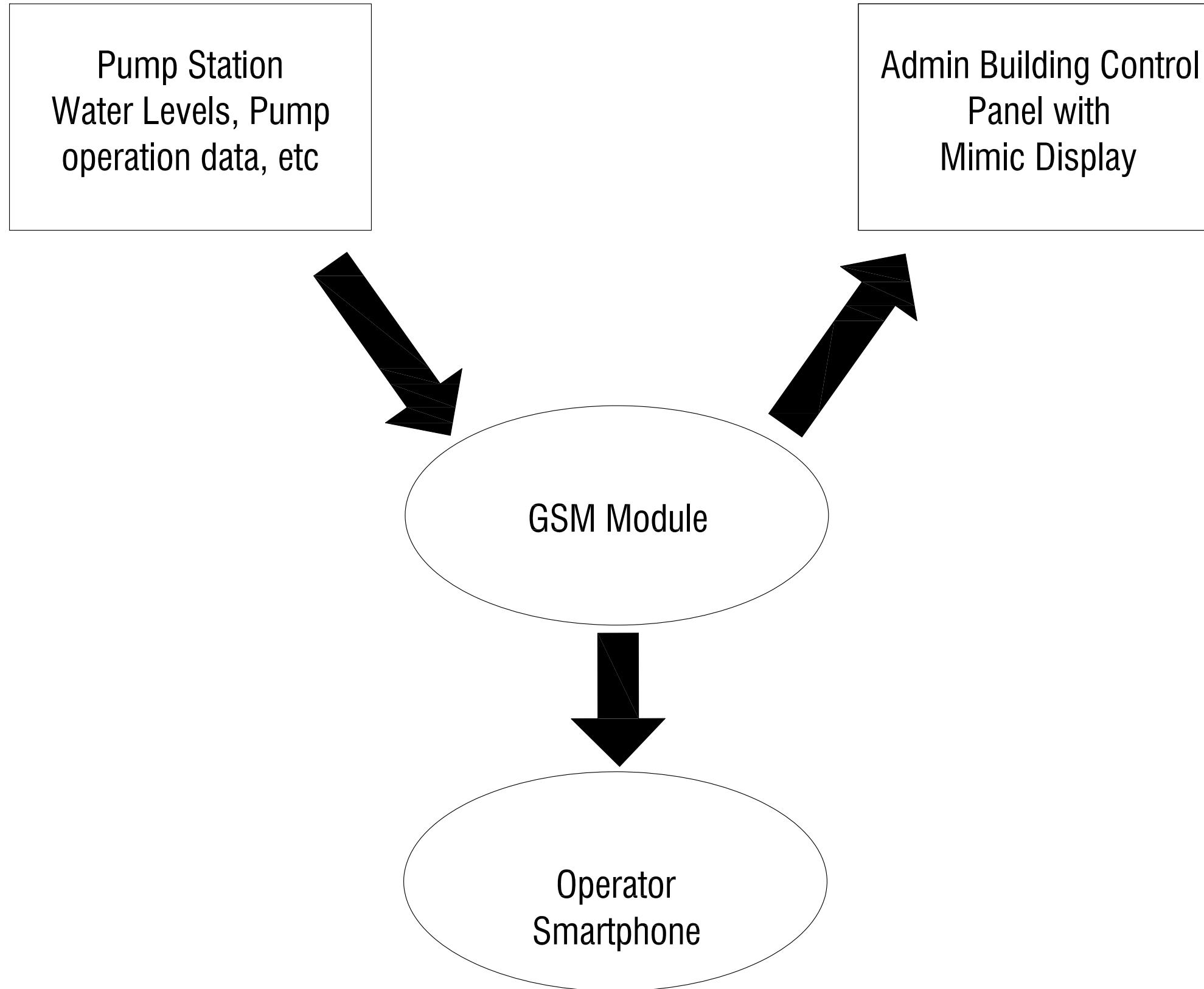

CONSULTANCY SERVICES FOR SURVEY & DESIGN
OF SEWERAGE FACILITIES IN HA. BAARAH, MALDIVES
CLIENT: MINISTRY OF ENVIRONMENT AND ENERGY

PROJECT NUMBER :-
DATE: MARCH 2017
ENGINEER :- Abdulla Wahid
CHECKED BY :-
DRAWN BY :- Mohamed Saif

Rev no	Date



RIYAN PRIVATE LIMITED

t : +9603315049 f : +9603310776
e : info@riyan.com.mv
w : www.riyan.com.mv
3rd floor, H. Azum, Ameenemoggu, Male'

Title: Overall process
Instrumentation Diagram

Page: E-05

The contents of these drawings remain as a property of Riyan Private Limited. Any use other than those expressly stated is a violation of this copyright

Pump Station Operation Control

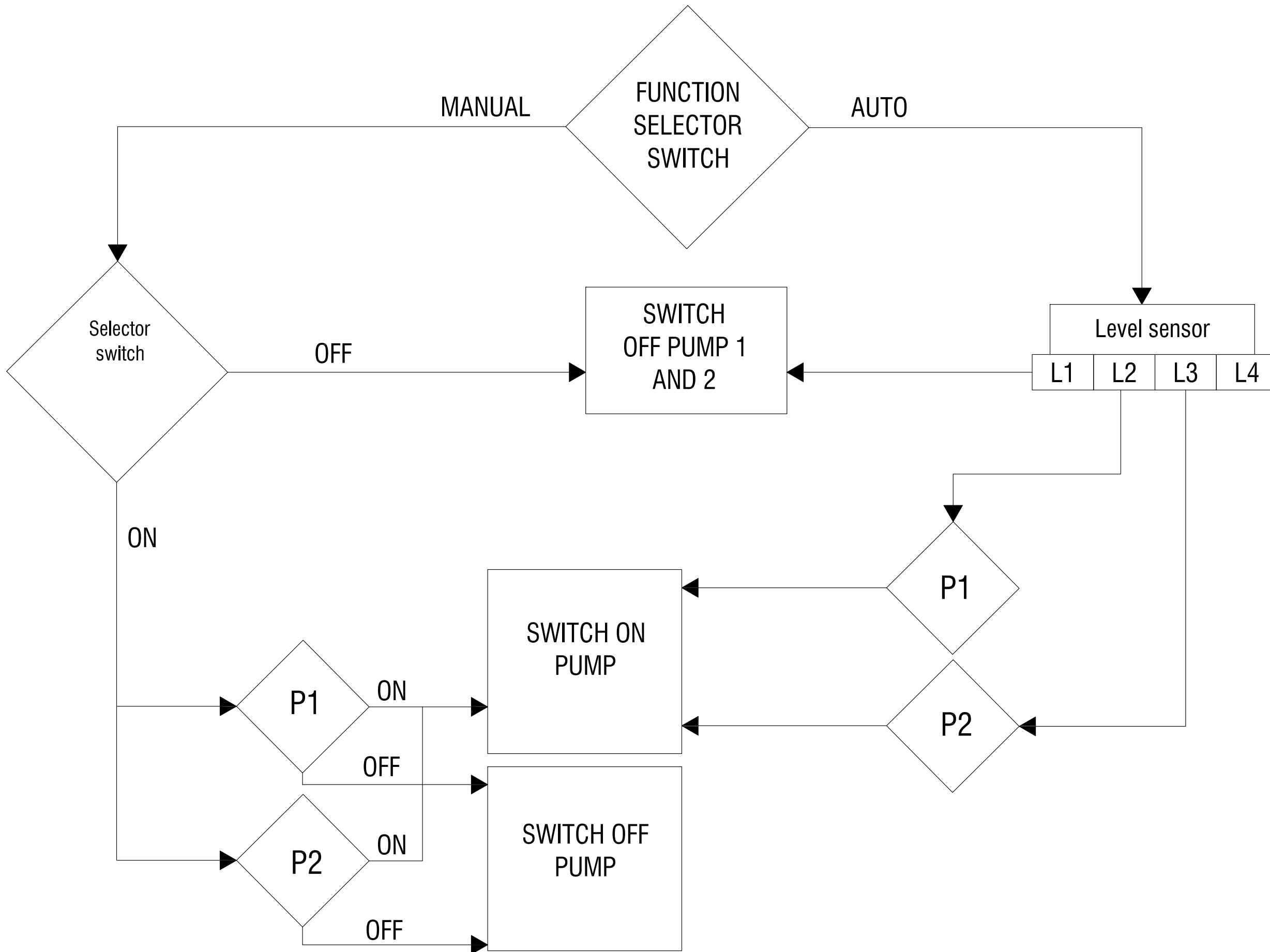

CONSULTANCY SERVICES FOR SURVEY & DESIGN
 OF SEWERAGE FACILITIES IN HA. BAARAH, MALDIVES
 CLIENT: MINISTRY OF ENVIRONMENT AND ENERGY
 PROJECT NUMBER :-
 DATE: MARCH 2017
 ENGINEER :- Abdulla Wahid
 CHECKED BY :-
 DRAWN BY :- Mohamed Saif

Rev no	Date



RIYAN PRIVATE LIMITED
 t : +9603315049 f : +9603310776
 e : info@riyan.com.mv
 w : www.riyan.com.mv
 3rd floor, H. Azum, Ameenemogau, Male'

The contents of these drawings remain as a property of Riyan Private Limited. Any use other than those expressly stated is a violation of this copyright.